

Data Sheet



Article number: 12859100035880

Description: KLEE-coil 859 100 035.880
M3,5 Brass

Measures

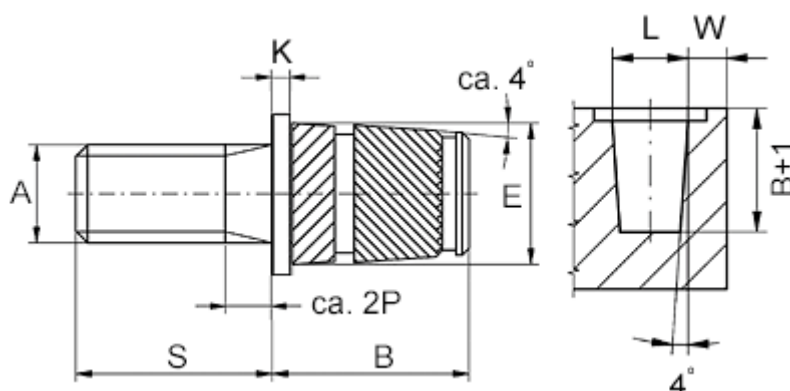

Flange diameter E1	= 7.2
Flange height	= 0.8
Male thread A	= M3,5x0,6
Min distance to edge W	= 1.8
Mounting length B	= 6.8
Outer diameter E	= 5.4
Pin length S	= 25
Recommended bore diameter W +0.1	= 5.2